



OWNER'S MANUAL & INSTALLATION GUIDE

Serenity HotSoak™

INSTALLER: This booklet must be given to the product owner.

Read all instructions before proceeding. All specifications are $\pm 3/8''$ and are subject to change without notice. Dimensions listed in inches.

Model # _____

Purchase Date _____

Serial # _____

Distributor _____



TABLE OF CONTENTS

PRODUCT WARRANTY REGISTRATION INFORMATION	4
INSTRUCTIONS PERTAINING TO A RISK OF FIRE, ELECTRIC SHOCK, OR INJURY TO PERSONS	5 – 6
USER INFORMATION	7
FCC CONSUMER INFORMATION	7
AQUATIC LIMITED WARRANTY	8
INSTALLATION INSTRUCTIONS	
Pre-Installation Procedures	9
Structural Preparation	10 – 11
Framing Diagrams	12
Deck Cutouts	13
Plumbing	14
Electrical Connections	14 – 16
Final System Test & Clean-Up	17
OPERATION INSTRUCTIONS	
HotSoak Operations	18
Bath-side On/Off Controls	18
Installation of Electronic On/Off Timer Control	19
Optional Chromatherapy Operation	20
To Replace LED Light	20
TUB CARE	
Maintenance	21
Repair	21
WATER QUALITY	
Chemical & Water Quality	22 – 24
TROUBLESHOOTING GUIDE	24
REPLACEMENT PARTS LIST	25
REPLACEMENT PARTS MAPS	26

AQUATIC Product Warranty Registration Information

Thank you for choosing an Aquatic bath. You have chosen one of the finest bath products in the industry! Aquatic supports your purchase with strong commitments to quality and customer satisfaction.

IMPORTANT!

To activate Product Warranty please register with Aquatic. Your product warranty must be registered and confirmed with Aquatic through the Serial Number on your unit. To register, please contact Aquatic.

(800) 945-2726 • www.aquaticbath.com/register

Please read and follow all of the instructions contained in this Owner's Manual before installing, operating or maintaining your HotSoak. In addition, you should continually refer to these instructions during the life of your HotSoak. Failure to comply with these instructions may invalidate your warranty. If you have any questions concerning installation, operation, maintenance or any other aspect of your Aquatic bath, please contact:

AQUATIC CUSTOMER SERVICE CENTER: (800) 945-2726

(The Troubleshooting Guide on page 24 may be helpful in answering some of your questions.)

NOTE: The installation and service of your HotSoak should be performed **ONLY** by a qualified electrician and plumber.

IMPORTANT!

This product **MUST BE WATER-TESTED** and inspected prior to installation or warranty will be voided. [See **TO INSPECT** on page 9.] Neither Aquatic nor the distributor will be responsible for removal or reinstallation costs should replacement of the bath be necessary.

PLEASE CHECK ENTIRE UNIT FOR ANY DAMAGE.

If it appears damaged, contact your Aquatic Distributor immediately. Aquatic warranty does not cover damage that occurs in transit.

SERIAL NUMBER LOCATION

The tub model and serial numbers are located above the pump area on the backside of the bathtub. Your installer should have a service access panel in this location.



AQUATIC

The bath people

Customer Service: 800.945.2726 • aquaticbath.com

INSTRUCTIONS PERTAINING TO A RISK OF FIRE, ELECTRIC SHOCK, OR INJURY TO PERSONS

WARNING: When using this unit, basic precautions should always be followed, including the following:

READ AND FOLLOW ALL INSTRUCTIONS:

- **WARNING:** Risk of lethal electric shock. To reduce risk of electric shock, connect only to circuits protected by a Ground-Fault Circuit-Interrupter (GFCI) or Residual Current Device (RCD).
- **DANGER:** To reduce the risk of injury, do not permit children to use this unit unless they are closely supervised at all times.
- Use this unit only for its intended use as described in this manual. Do not use additional attachments and/or equipment not recommended by the manufacturer.
- Never drop or insert any object into any opening.
- Do not operate this unit without the guard over the suction fitting.
- The unit must be connected only to a supply circuit that is protected by a ground-fault circuit-interrupter (GFCI). Such a GFCI should be provided by the installer and should be tested on a routine basis. To test the GFCI, push the test button. The GFCI should interrupt power. Push the reset button. Power should be restored. If the GFCI fails to operate in this manner, there is a ground current flowing, indicating the possibility of an electric shock. Do not use this unit. Disconnect the unit and have the problem corrected by a qualified service representative before using.
- To reduce the risk of injury, enter and exit the bathtub slowly.
- This product is intended for indoor use only. Installing this unit outdoors could cause personal injury and will void your warranty.

SAVE THESE INSTRUCTIONS.

CALIFORNIA PROP. 65

 **WARNING:** This product can expose you to chemicals including styrene and styrene compounds, which are known to the State of California to cause cancer and birth defects or other reproductive harm. For more information go to www.p65warnings.ca.gov

Your safety and the safety of others are very important.

We have provided many important safety messages in this manual and on your appliance. Always read and obey all safety messages.



This is the safety alert symbol. This symbol alerts you to potential hazards that can kill or hurt you and others.

All safety messages will follow the safety alert symbol and either the word "DANGER" or "WARNING." These words mean:

 **DANGER**

You can be killed or seriously injured if you don't immediately follow instructions.

 **WARNING**

All safety messages will tell you what the potential hazard is, tell you how to reduce the chance of injury, and tell you what can happen if the instructions are not followed.

INSTRUCTIONS PERTAINING TO A RISK OF FIRE, ELECTRIC SHOCK, OR INJURY TO PERSONS

WARNING: WHEN USING THIS UNIT, THESE BASIC PRECAUTIONS SHOULD BE FOLLOWED.

This manual contains information and instructions for proper operation and maintenance of your HotSoak. Failure to follow these instructions could result in personal injury, electrical shock or fire.

READ AND FOLLOW ALL INSTRUCTIONS

DANGER! TO REDUCE THE RISK OF INJURY:

1. Do not permit children to use this unit unless they are closely supervised by an adult at all times. Supervision is also required when HotSoak is used by an elderly or handicapped individual.
2. Use this unit only for its intended use as described in this manual. Do not use attachments not recommended by the manufacturer.
3. Do not operate this unit without guard over the suction fitting.
4. The water in a bath should never exceed 40°C (104°F). Water temperatures between 38°C (100°F) and 40°C (104°F) are considered safe for a healthy adult. Use time should be limited to approximately 30 minutes, followed by a shower to cool down. Longer exposures may result in hyperthermia. The symptoms of this condition are nausea, dizziness and fainting, which can be fatal. Lower water temperatures are recommended for extended use (exceeding 10-15 minutes) and for young children.
5. Since excessive water temperatures have a high potential for causing fetal damage during the early months of pregnancy, pregnant or possibly pregnant women should limit bath water temperatures to 38°C (100°F).
6. The use of drugs or alcoholic beverages before or during bath use may lead to unconsciousness with the possibility of drowning. Never use the bath while under the influence of alcohol, anticoagulants, stimulants, antihistamines, vasoconstrictors, vasodilators, hypnotics, narcotics or tranquilizers.
7. Persons with a medical history of heart disease, low or high blood pressure, circulatory system problems, or diabetes should consult a physician before using HotSoak.
8. Persons using medication should consult a physician before using HotSoak since medication may induce drowsiness while other medication may affect heart rate, blood pressure and circulation.

DANGER: To reduce the risk of injury, enter and exit the bath slowly.

WARNING: Never operate electrically connected devices in or near the bath. Never drop or insert any object into any opening within the bath.

This unit must be connected to a supply circuit that is protected by a Ground Fault Circuit Interrupter (GFCI). Such a device should be installed by a licensed electrician and should be tested on a regular basis (at least monthly). To test the GFCI push the TEST button. The GFCI should interrupt the power. Push the RESET button and the power should be restored. If the GFCI fails to operate in this manner there is the possibility of an electric shock, DO NOT USE. Disconnect the unit and have the problem corrected by a qualified service technician. To avoid the possibility of personal injury and discoloration of the acrylic surface, the inlet water temperature should not exceed 60°C (140°F). The bath should be drained after each use. Each bather should start their bath with fresh water.

CAUTION: DO NOT USE HARSH ABRASIVES OR SOLVENTS FOR CLEANING THIS UNIT.

**INSTALLER/OWNER BEARS ALL RESPONSIBILITY TO COMPLY WITH ALL STATE AND LOCAL CODES
WHEN INSTALLING THIS PRODUCT.**

SAVE THESE INSTRUCTIONS

USER INFORMATION

Please note:

No servicing of this product should be done by the user. There are no user serviceable parts. All controls are located in the control recesses on the lip of the tub. These are the only controls that should be used by the consumer. Do not change or alter any of these controls under any circumstances.

Motors are self-lubricating - No lubrication required.

FCC CONSUMER INFORMATION

Electrical Installation Information Listed on pages 14-16.

This equipment generates and uses radio frequency energy and if not installed and used properly, that is, in strict accordance with the manufacturers instruction, may cause interference to radio and television reception. It has been type tested and found to comply with the limits for a class B computing device in accordance with the specifications in subpart J of part 15 of the FCC rules, which are designed to provide reasonable protection against such interference in a residential installation. However, there is no guarantee that interference will not occur in a particular installation. If this equipment does cause interference, which can be determined by turning the equipment on and off, the user is encouraged to try to correct the interference by one or more of the following measures:

- Reorient the receiving antenna.
- Relocate the receiver with respect to the bath tub.
- Move the receiver away from the bath.
- Plug the receiver into a different outlet so that the receiver and bath are on different branch circuits.
- If necessary, the user should consult the dealer or an experienced radio/television technician for additional suggestions.
- The user may find the following booklet prepared by the FCC helpful: "How To Identify and Resolve Radio-TV Interference Problems." It is available from the U.S. Government Printing Office, Washington, DC 20402, Stock No., 004-000-00345-4.



Aquatic Limited Warranty
Serenity HotSoak™
Limited Warranty For Original Consumer For Household Usage

WHAT PRODUCTS ARE COVERED

Structures and surface finishes on the HotSoaks and their support systems including equipment, components, attachments and plumbing equipment. Different warranty periods apply to specific components.

Warranty Periods for Specific Components

10 YEAR STRUCTURAL WARRANTY FOR HOTSOAKS SHELL

Aquatic extends to the original consumer purchaser (the "Purchaser") of the acrylic, fiberglass reinforced shell of HotSoaks a limited warranty that the shell will retain its structural integrity and configuration and be free of water loss due to a defect in the tub shell for a period of 10 years from the date of purchase or 11 years from date of manufacture. This limited structural warranty does not apply to attachments to the acrylic, fiberglass reinforced shell, such as plumbing, fittings and other apparatus; this support equipment pieces is covered below.

10 YEAR SURFACE WARRANTY FOR FACE OF HOTSOAKS

The interior surface/face of a HotSoak is warranted against fading, blistering, cracking and delamination due to defects in the surface materials for a period of 10 years from the date of purchase or 11 years from date of manufacture. This surface warranty extends to defects due to surface material mixing or molding. This surface warranty does not apply to fading, cracking, delamination or blistering due to excessive wear, sun fading or scouring due to cleaning.

2 YEAR EQUIPMENT WARRANTY FOR SUPPORT EQUIPMENT, COMPONENTS, CONTROLS & PLUMBING EQUIPMENT

All support equipment, components, controls and plumbing equipment on HotSoaks are warranted for 2 years from date of purchase or 3 years from date of manufacture, against defects in workmanship and materials. Fuses and pillows are not included in this limited warranty.

EXCLUSIVE REMEDY

Aquatic shall, as its sole obligation, and Purchaser's sole and exclusive remedy for any breach of the limited warranty set forth herein, repair or replace the affected components of any defective HotSoak. If Aquatic determines that repair or replacement of the entire defective HotSoak is not commercially practicable, Aquatic may accept return of the HotSoak and refund the then-current list price of the HotSoak (or, if the HotSoak has been discontinued, of the most nearly comparable current product) to Purchaser for the defect. Any repair, replacement or warranty service by Aquatic hereunder will not extend the applicable warranty periods set forth herein. Unless otherwise agreed upon by Aquatic in writing, Purchaser will bear the costs of access, de-installation, re-installation and transportation of the HotSoak to Aquatic and back to Purchaser.

WHAT YOU MUST DO

To obtain warranty service under these warranties:

1. You must be the Purchaser of the HotSoak.
2. You must give prompt written notice to Aquatic at the address detailed below of any defect claim within the warranty period and provide us with any substantiation that we may reasonably request.
Write to: Aquatic 1521 N. Cooper, Suite 500, Arlington, TX. 76011.
3. HotSoaks must have been installed and maintained in accordance with standard industry practice and with Aquatic's instructions contained in the Owner's Manual and Installation Guide. Please contact Aquatic at the address stated above to obtain a copy of Aquatic's Owner's Manual and Installation Guide.

EXCLUSIONS

These limited warranties are null and void if:

1. The HotSoak is subject to damage during shipping by carriers, faulty installation, maintenance, abuse, accident or other damages.
2. The HotSoak is installed outdoors.
3. The HotSoak is not installed in accordance with standard industry practice and Aquatic's instructions contained in the Owner's Manual and Installation Guide.
Please contact Aquatic at the address stated above to obtain a copy of Aquatic's Owner's Manual and Installation Guide.
4. Unreasonable use of the HotSoak occurs (including any use for non-bathing purposes or failure to provide reasonable and necessary maintenance as specified in Aquatic Owner's Manual and Installation Guide supplied with the HotSoak).
5. The HotSoak is altered, customized, or modified without Aquatic's prior written approval.

LIMITATIONS

1. Aquatic HotSoaks sold to Purchasers for industrial, commercial or hotel use are warranted for two years from the original date of purchase or 3 years from date of manufacture, with a limited warranty that the shell will retain its structural integrity and configuration and be free of water loss due to a defect in the HotSoak. The interior surface/face of the HotSoak is warranted against fading, blistering, cracking and delamination due to defects in the surface materials. All support equipment, components, controls and plumbing equipment sold to Purchasers for industrial, commercial or hotel uses on the support equipment, controls, or plumbing is warranted for 1 year from date of purchase or 2 years from date of manufacture. Fuses and pillows are not included in this limited warranty. Aquatic reserves the right to furnish a substitute or replacement HotSoak component in the event the HotSoak component is discontinued or otherwise unavailable.
2. THESE WARRANTIES ARE NON-TRANSFERABLE TO ANY OTHER PURCHASER OR PARTY OTHER THAN THE PURCHASER. NO OTHER AGENT OR PARTY CAN GIVE ANY OTHER WARRANTY OR PROMISE. THIS IS THE SOLE WARRANTY FOR YOUR AQUATIC HOTSOAK.
3. Building Code Compliance is not covered by this limited warranty. Local building codes vary considerably, the Purchaser of the HotSoak is responsible for checking with local building or plumbing contracts to insure local code compliance before installation.
4. Your warranty period starts (begins to run) at the earlier of 1) the beginning of installation of your HotSoak in a home, or 2) the purchase of your HotSoak, and shall never exceed 11 years from the date the HotSoak is manufactured for its shell or finish, or 3 years from the manufacture of plumbing supplies and accessories.

GENERAL

EXCEPT FOR THE LIMITED WARRANTIES SET FORTH ABOVE, THE HOTSOAKS ARE PROVIDED "AS IS" WITHOUT ANY REPRESENTATIONS OR WARRANTIES OF ANY KIND. AQUATIC EXPRESSLY DISCLAIMS ALL OTHER WARRANTIES, EXPRESS, IMPLIED, INCLUDING BUT NOT LIMITED TO ANY WARRANTIES OF MERCHANTABILITY, FITNESS FOR A PARTICULAR PURPOSE, TITLE, AND NON-INFRINGEMENT OF THIRD PARTY RIGHTS. AQUATIC DOES NOT WARRANT THAT THE HOTSOAKS FURNISHED HEREUNDER WILL MEET PURCHASER'S REQUIREMENTS OR THAT THE OPERATION OF THE PRODUCT WILL BE UNINTERRUPTED OR DEFECT-FREE OR THAT ALL DEFECTS WILL BE CORRECTED. PURCHASER ACKNOWLEDGES THAT IT HAS RELIED ON NO WARRANTIES OTHER THAN THE EXPRESS WARRANTIES PROVIDED HEREIN.

IN NO EVENT WILL AQUATIC BE LIABLE FOR ANY INDIRECT, SPECIAL, INCIDENTAL, EXEMPLARY OR CONSEQUENTIAL DAMAGES; INCLUDING WITHOUT LIMITATION ANY LOST PROFITS AND COSTS OF PROCUREMENT OF SUBSTITUTE PRODUCT, ARISING OUT OF OR RELATED TO A BREACH OF THIS LIMITED WARRANTY.

Some states do not allow exclusions or limitations on implied warranties. Thus, the above exclusions or limitations may not apply. This warranty gives you specific legal rights. Purchaser may also have other rights which may vary from state to state.

INSTALLATION INSTRUCTIONS

READ ALL INSTRUCTIONS CAREFULLY BEFORE INSTALLATION

PRE- INSTALLATION INSTRUCTIONS

PLEASE NOTE: THE MANUFACTURER ACCEPTS A $\pm 3/8"$ VARIANCE. THERE ARE VARIATIONS ON EACH TUB AND SPECIFICATIONS ARE SUBJECT TO CHANGE AS WE IMPROVE UPON OUR PRODUCT AS REQUIRED.

THE DIMENSIONS NEEDED FOR SITE PREPARATION AND STRUCTURE BUILDINGS SHOULD BE MEASURED FROM THE TUB; AQUATIC ASSUMES NO RESPONSIBILITY FOR PREPARATORY WORK.

Note: A good knowledge of construction techniques, plumbing and electrical installation according to codes are required for proper installation. We recommend that a qualified licensed contractor perform the installation of all Aquatic products. Our warranty does not cover improper installation related problems.

1. Immediately upon receiving your Aquatic HotSoak inspect it thoroughly for freight damage. If necessary, contact your dealer/distributor immediately (your dealer/distributor must contact Aquatic within 24 hours of receiving unit to file a claim.) Should inspection indicate any damage, do not install the bath. Damage or defect to the tub surface claimed after the bath is installed is not covered under the warranty.
2. Remove packing material between tub and pump/heater (most models).
3. All baths are filled with water and operated in our manufacturing facility prior to shipment. Inspectors ensure watertight operation, however rough handling may cause leaks which may be detected prior to installation.

TO INSPECT:

1. Place the tub in an area where it may be drained after testing.
2. Fill the tub to the overflow and allow to stand for a few minutes.
3. Plug in pump cord and run pump for 10 minutes.
4. Inspect the tub completely. Any defect must be reported to Aquatic prior to installation in order to have it covered by warranty. Should inspection indicate any damage or leaks, do not install the bath.

Damage or leaks claimed after the bath is installed are not covered under the warranty.

5. Check to ensure that your installation will conform to all applicable codes and secure necessary permits. All electrical and plumbing connections should be made by qualified electricians and plumbers.

DAMAGE OR LEAKS CLAIMED AFTER THE BATH IS INSTALLED ARE NOT COVERED UNDER THE WARRANTY.

WARNING: FAILURE TO FOLLOW THESE INSTRUCTIONS DURING INSTALLATION WILL RESULT IN TERMINATION OF THE WARRANTY:

Do not lift the tub by any portion of the plumbing or pump.
Do not stand in the tub during construction.

DO NOT MAKE ANY ALTERATIONS, ADDITIONS, OR DELETIONS TO THE WHIRLPOOL SYSTEM, PUMP OR BATH.

WARNING: HotSoak pump and piping are factory assembled. Relocation of pump or other modifications could adversely affect the performance and safe operation of this HotSoak. Aquatic shall not be liable under its warranty or otherwise for personal injury or damage caused by any such unauthorized modification.

QUIETNESS OF OPERATION: Aquatic has engineered their baths from base to lip to ensure quality, value, functional design, and maximum bathing comfort. However installation is accountable for as much as 50% of a tub's operating quietness. Please ensure the following:

- The floor structure is adequate to support the installation.
- For quieter operation and heat retention conservation, the walls surrounding the bathtub may be insulated.
- Insulate the tub surround. Do not allow any insulation to come within 3 feet of the pump. The area around the pump must be clean and free of any foreign matter.
- Leave 1/8" to 3/16" gap between tub lip and surround.
- Spread a bed of cement mortar on the floor or subfloor under the tub to reduce vibration and noise.

INSTALLATION INSTRUCTIONS

STRUCTURAL PREPARATION

Note: The bath should remain in its shipping carton until time of installation.

- Literature dimensions are for reference only. Installation dimensions should be taken directly from the tub.
- Building materials and wiring should be routed away from the pump or other heat-producing components. An access panel of 16" x 16" minimum must be provided at the pump end of the tub allowing sufficient clearance to make final connections and for servicing the pump and power panel. Access may be through the wall or platform apron at the end of the unit. In the case of sunken installations, access should be made through the ceiling below.

**IT IS THE INSTALLER'S RESPONSIBILITY TO PROVIDE SUFFICIENT SERVICE ACCESS.
MAKE ABSOLUTELY CERTAIN THAT ACCESS PANELS AND/OR SERVICE OPENINGS ARE PROPERLY
PLACED AND THAT ALL POSSIBLE AREAS WHERE SERVICE MAY BE REQUIRED ARE ACCESSIBLE.**

- Install the drain fitting to the bath. **THE DRAIN FITTING WILL PROTRUDE BELOW THE BASE OF THE TUB APPROXIMATELY 1 1/2"**. Clearance must be provided for the drain by cutting away the subfloor (where possible) or by blocking below the tub as may be required. **NOTE:** Watertight installation of the drain and overflow is the installer's responsibility. Drain and/or overflow leakage is not included in the warranty of this product.
WARNING: Factory skirts do not allow for blocking up of the tub base. All blocking must be solid and provide uniform support to the tub base.
- Tub must rest entirely on the base. **DO NOT SUPPORT THE WEIGHT OF THE TUB BY THE RIM.** Where leveling is required, and to reduce vibration noise, prepare a bed of wet mortar in area where tub is to be installed. Carefully level unit, ensuring that uniform support is given to all areas of the base and no portion of the lip is bearing weight.
- Frame out under the tub rim as shown in one of the illustrations below. **NOTE:** Due to the variety of installations possible, framing procedures other than those described may be required. Plumb in selected location using a level. Level front to back and across both sides. A ledge under the rim, or an apron without a ledge, may be constructed as required (see Diagram 1A and 1B). Where installation will be against a wall, stud wall framing should allow for wall sheathing material to run full length to the floor (see Diagram 1C). Install tub firmly against sheathing as dicated, with blocking below rim to prevent deflection or movement of tub. To prevent a rocking movement of tub after installation, it is important to have rim in contact, but not supported by blocking material.
- When placing the tub on a platform or cut out (see Diagrams 1A and 1D), the opening should be 1" smaller than the specified rim dimensions. Extreme care must be taken in this type of installation to ensure the tub will come to rest entirely on the base.

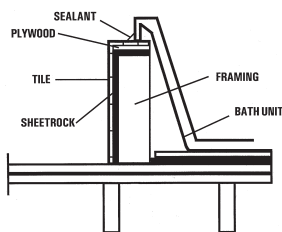

1A Ledge Installation - 1

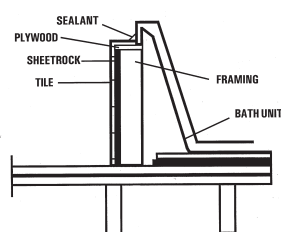

1B Ledge Installation - 2

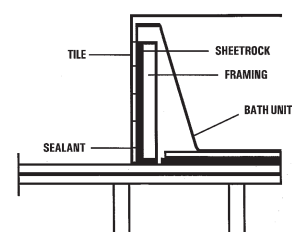

1C Apron Installation

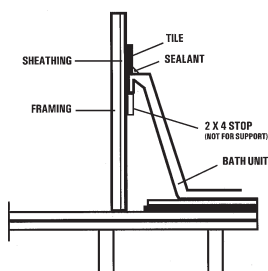

1D Wall Installation

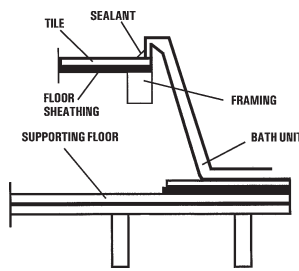

1E Sunken Installation

INSTALLATION INSTRUCTIONS

STRUCTURAL PREPARATION (CONTINUED)

7. Another installation option is that of a tile flange. Aquatic offers a factory installed tile flange for all rectangular and corner-unit tubs.
8. Install the bath unit per the instructions provided in this manual. **CAUTION: THE TILE FLANGE DOES NOT SUPPORT THE TUB!** A ledger board must be provided under the bath rim as indicated in the installation instructions. Take care to ensure tub is not hanging from the ledger boards, as this will void your warranty.
9. Use nails or screws to secure the flange into the studs around the bath.
NOTE: Before tub is used, the HotSoak system should be cleaned in accordance with the procedures on page 21 of this manual.
10. Install water resistant drywall against the tile flange and flush to the top of the tub deck. Install the tile or other finishing materials. Apply a second bead of silicone between the first course of tile and the bath deck.

INSTALLATION INSTRUCTIONS

FRAMING DIAGRAMS

1. Protect interior of tub throughout installation process.
2. Framing and supports will vary according to the model and type of installation selected.
3. Please refer back to the unit's Technical Data sheet for specific dimensions located at www.aquaticbath.com.

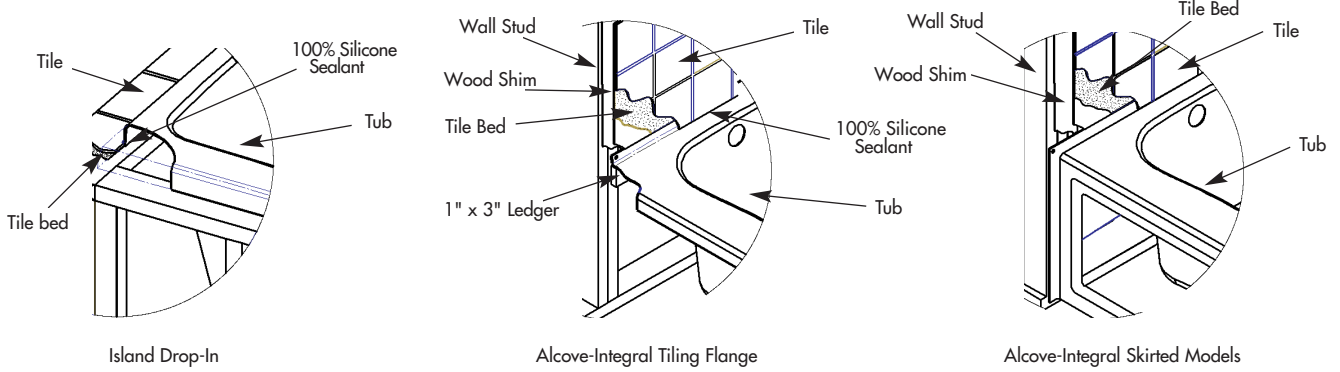

	RECTANGULAR MODELS	CORNER MODELS	OVAL MODELS
--	--------------------	---------------	-------------

ALCOVES		<p><i>Note: For Skirt Installation disregard front framing</i></p>	<p>A₁ = end drain A₂ = center drain</p>														
ISLANDS																	
INTEGRALLY SKIRTED MODELS																	
<table border="1" style="width:100%; border-collapse: collapse;"> <thead> <tr> <th colspan="2" style="background-color: #cccccc;">LEGEND</th> </tr> </thead> <tbody> <tr> <td style="width:15%;">AW</td> <td>Overall Width</td> </tr> <tr> <td>DH</td> <td>Deck Height</td> </tr> <tr> <td>ID</td> <td>Inner Depth</td> </tr> <tr> <td>IW</td> <td>Inner Width</td> </tr> <tr> <td>LH</td> <td>ledger Height</td> </tr> <tr> <td>LD</td> <td>ledger Depth</td> </tr> </tbody> </table>				LEGEND		AW	Overall Width	DH	Deck Height	ID	Inner Depth	IW	Inner Width	LH	ledger Height	LD	ledger Depth
LEGEND																	
AW	Overall Width																
DH	Deck Height																
ID	Inner Depth																
IW	Inner Width																
LH	ledger Height																
LD	ledger Depth																
<table border="1" style="width:100%; border-collapse: collapse;"> <tbody> <tr> <td style="width:15%;">A</td> <td>6" x 12" Box-outs</td> </tr> <tr> <td>B</td> <td>Leveled Supports 1" x 3" Ledges</td> </tr> <tr> <td>C</td> <td>16" x 16" minimum access on pump end</td> </tr> </tbody> </table>				A	6" x 12" Box-outs	B	Leveled Supports 1" x 3" Ledges	C	16" x 16" minimum access on pump end								
A	6" x 12" Box-outs																
B	Leveled Supports 1" x 3" Ledges																
C	16" x 16" minimum access on pump end																

INSTALLATION INSTRUCTIONS

DECK CUTOUTS

A paper template will be enclosed with all rounded-edged models. Use the directions on the paper template for cutout dimensions. If the paper template has been lost or needs replacement, please contact Customer Service at: 800.945.2726.

USING THE CUTOUT TEMPLATE

Draw a center line horizontally and vertically on a 1" thick plywood deck. Place the template in the upper left hand quadrant, noted as Quadrant 1 on the diagram below. Trace template to outline Quadrant 1. Flip the paper cutout horizontally, making sure to match the dotted center line on the template with the center line on the plywood. Trace again to outline Quadrant 2. Repeat until the remaining quadrants of the cutout have been traced.

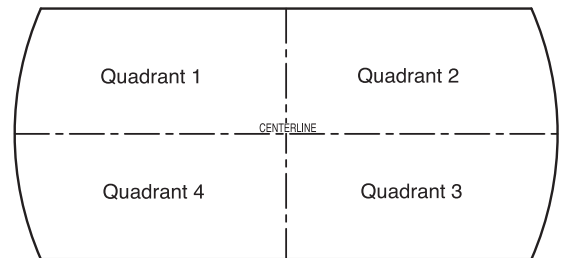
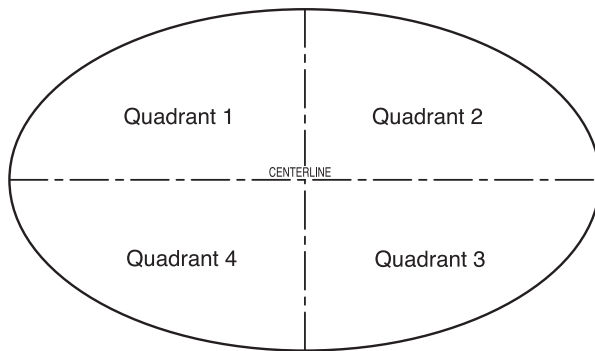

CORNER MODELS

On a 1" thick plywood deck, place the template in the upper section noted as Section 1 in the diagram. Trace Section 1 to establish the centerline and front edge of the cutout. Flip the template along the centerline and trace to complete the other half of the unit noted as Section 2 in the diagram below.

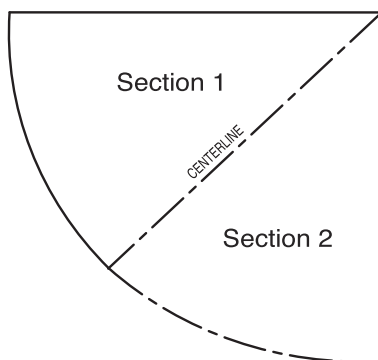

RECTANGLE MODELS

Using a 1" thick plywood deck, the cutout should be 2" smaller than the overall tub dimensions (length & width), for 1" overhangs on all sides. For example, a 72" x 42" unit should have a deck cutout of 70" x 40". Additional dimensions can be found in the technical data sheets at www.aquaticbath.com.

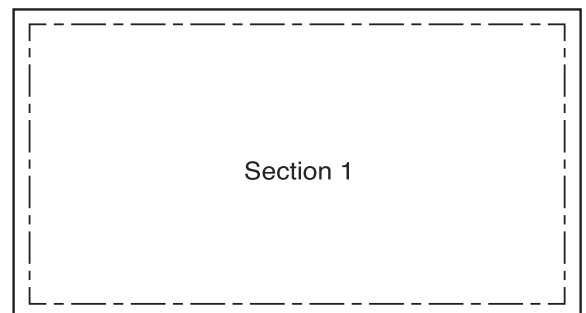

INSTALLATION INSTRUCTIONS

PLUMBING

1. After securing tub in place, normal waste and overflow, water spout and valves are installed per normal plumbing procedures, in accordance with all state and local standards.
2. Install standard 1-1/2" trap to drain and overflow. Before proceeding make final operational check by filling tub with water to overflow and operate pump for 5 minutes. Check for leaks carefully both while pump is running and has been turned off. Allow water to stand in tub for at least 30 minutes before draining. **AQUATIC WILL NOT BE RESPONSIBLE FOR WATER DAMAGE OF ANY KIND IN CONNECTION WITH ONE OF OUR BATHS.**
3. When selecting fill spout location, check to ensure that spout is long enough to clear the tub rim from its desired location. If installation is to be on the tub deck, check the back side of tub for adequate space for connection to water lines before drilling or cutting tub.
4. A service access panel of a minimum of a 16" square must be provided adjacent to motor/pump/heater assembly.

NOTE: For Rough-in measurements please refer to unit's technical data sheet.

ELECTRICAL CONNECTIONS

WARNING: ALL ELECTRICAL CONNECTIONS SHOULD BE MADE BY A LICENSED, LOCALLY CERTIFIED ELECTRICIAN, IN ACCORDANCE WITH THE REQUIREMENTS OF THE NATIONAL ELECTRICAL CODES AND PROCEDURES.

WARNING: WHEN USING ELECTRICAL PRODUCTS, BASIC PRECAUTIONS SHOULD ALWAYS BE FOLLOWED, INCLUDING THE FOLLOWING.

HOTSOAK

DANGER: RISK OF ELECTRIC SHOCK! This unit requires one dedicated 20 AMP, 120V GFCI only (Please see DIAGRAM ON PAGE 16). A GFCI is not supplied, however we do specify its use. All known code authorities require a GFCI.

BONDING WIRE: Connect a #8 bare-copper bonding wire from the pump motor/heater to the cold water plumbing or other suitable ground. Grounding is required. **For built-in and custom units, install to permit access for servicing.**

HOTSOAK with CHROMATHERAPY

HotSoak with chromatherapy requires two dedicated 20 AMP, 120V GFCI only (PLEASE SEE DIAGRAM ON PAGE 16). A GFCI is not supplied, however we do specify its use. All known code authorities require a GFCI.

BONDING WIRE: Connect a #8 bare-copper bonding wire from the pump motor/heater to the cold water plumbing or other suitable ground. Grounding is required. **For built-in and custom units, install to permit access for servicing.**

CAUTION: Before use of the unit, test the GFCI for proper operation.

INSTALLATION INSTRUCTIONS

ELECTRICAL CONNECTIONS

Serenity HotSoak Component Breakdown

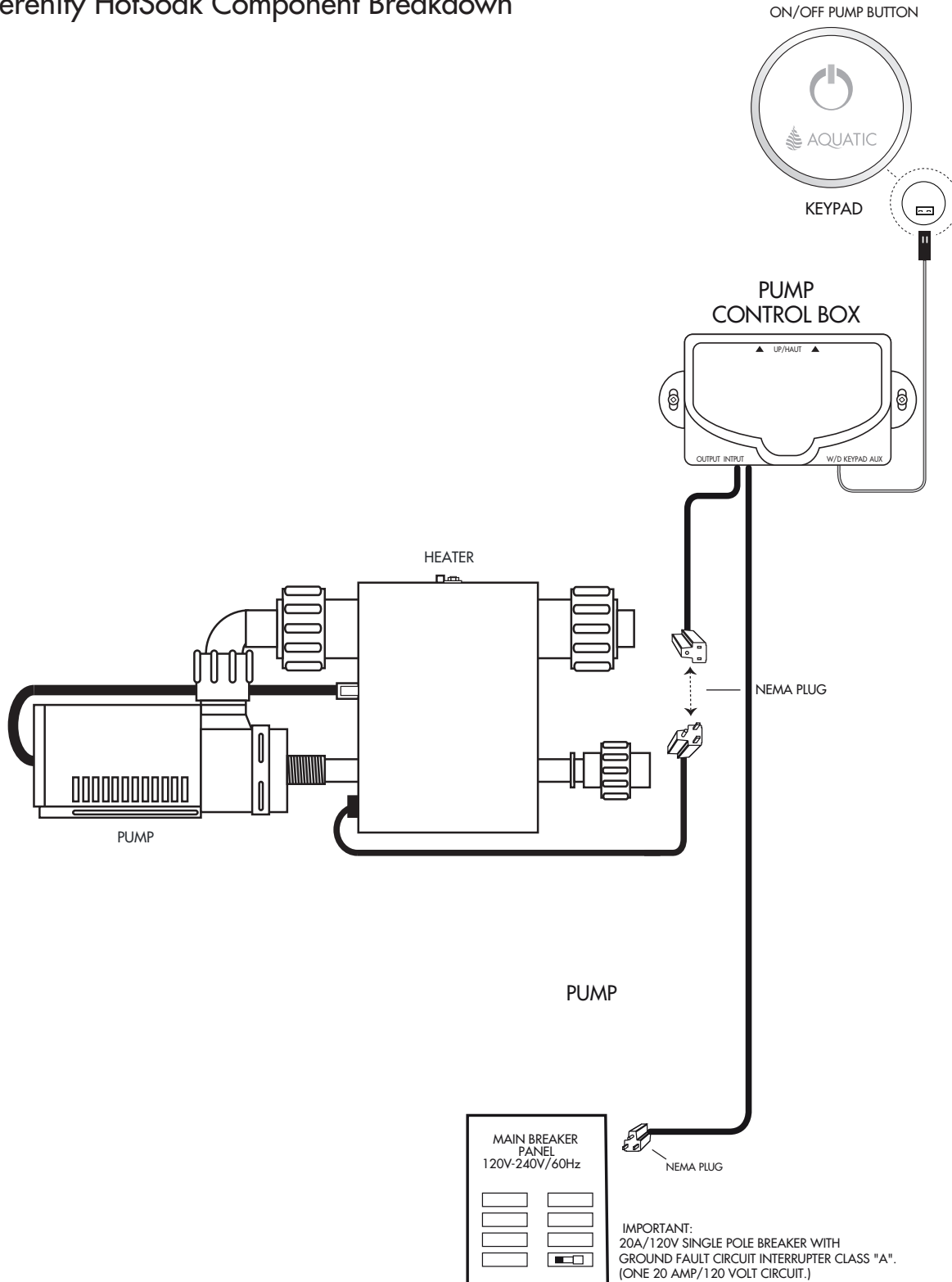

Diagram 2

INSTALLATION INSTRUCTIONS

ELECTRICAL CONNECTIONS

HotSoak with Optional Chromotherapy LED

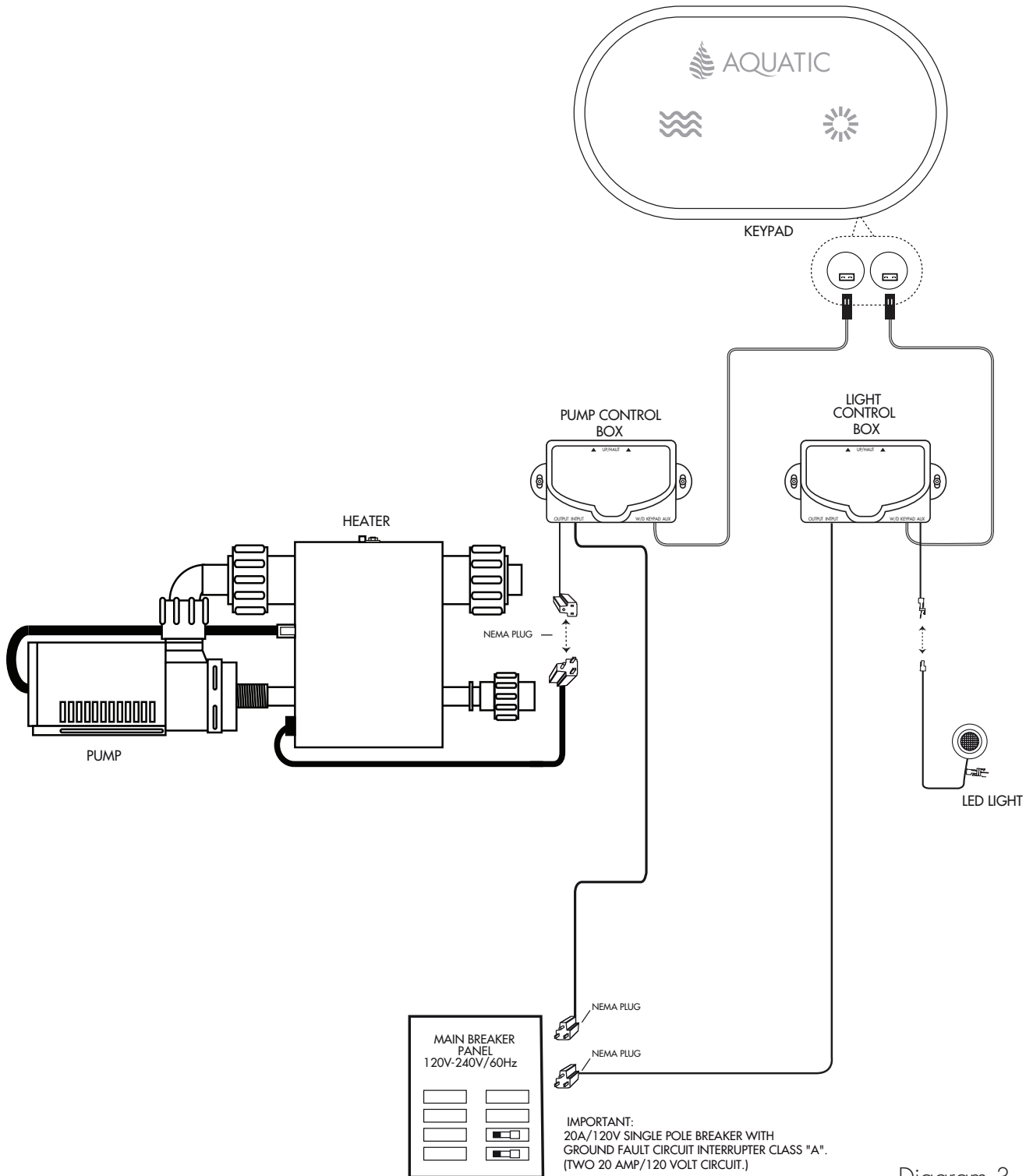

Diagram 3

INSTALLATION INSTRUCTIONS

FINAL SYSTEM TEST & CLEAN-UP

System Test

To test system, follow these steps in order listed:

1. Fill clean tub with water to a point no less than 2" (50) above the highest circulation portal.
2. To test the Ground-Fault Circuit-Interrupter (GFCI), push the test button. The GFCI should interrupt power. Push the reset button. Power should be restored. If the GFCI fails to operate in this manner, there is a ground current flowing, indicating the possibility of an electric shock. Do not use this unit. Disconnect the unit and have the problem corrected by a licensed electrician before using.
3. Push on/off button once to turn HotSoak on.
4. Allow system to run a full 10 minutes.
5. Through access door or removable skirt, check for leaks in HotSoak plumbing system. Make sure half-unions at both ends of pump are hand-tight. If leakage is occurring at any other points, notify distributor.
6. If any electrical malfunctions occur, immediately unplug the unit and consult a licensed electrician. Malfunctions of the pump motor/heater, electronic controls or the circulating system should be reported to the distributor who supplied the bathtub.

Clean-up

1. Remove all construction residue and foreign materials. Wipe unit clean with a damp rag, otherwise staining may occur.
2. Plaster may be removed by scraping with the edge of a piece of wood or rigid plastic. DO NOT use metal scraper. For spots left by plaster or grout: rub lightly with a liquid detergent (Spic-N-Span® or similar) on a damp cloth or sponge.
3. DO NOT use abrasive cleaners, scouring powders, steel wool, wire brushes or anything else that may harm or dull the surface.
4. Paint, tar or stubborn stains may be removed with paint thinner, turpentine or rubbing alcohol. To avoid discoloration, cleaners containing petroleum distillate must not remain on surfaces. NEVER use lacquer thinner or chlorinated solvents.
5. Dulled areas can be restored to a high gloss with white or cream-colored automotive rubbing compound, followed by application of carnauba wax or white or cream automotive paste wax and buffing.
6. Major gouges require professional repair. Contact Aquatic to arrange factory-authorized repair services.

OPERATION INSTRUCTIONS

HOTSOAK OPERATIONS

Operation of the inline maintenance heater is completely automatic. The heater will help maintain the temperature of the water in the tub. The heater includes the following components.

THERMOSTAT: The "Smart Thermostat" requires no adjustment and will automatically maintain the water temperature at 100° F - 104° F. Heater comes on at 100° F (low limit). If the bath is too warm, simply adjust by adding cold water.

HIGH LIMIT: The heater includes an exclusive "Intelligent High-Limit". This safety circuit will not "false trip" from hot tap water. It will only turn the heater off if the thermostat fails. To reset, simply press the red button. If the high-limit trips frequently, contact Aquatic

INDICATOR LIGHT: The light turns on when the heater is operating.

PRESSURE/VACUUM SWITCH: The heater is equipped with a preset pressure or vacuum switch. The pump must be running with water flowing to the tub to allow the heater to turn on.

CAUTION: Before use of the unit, test the GFCI for proper operation. The pump/heater should turn off when the GFCI "Test" button is pushed.

WARNING - Prolonged Immersions in Hot Water May Induce Hyperthermia. Hyperthermia occurs when the internal temperature of the body reaches a level several degrees above the normal body temperature of 98.6° F. The symptoms of hyperthermia include an increase in the internal temperature of the body, dizziness, lethargy, drowsiness, and fainting. The effects of hyperthermia include (1) failure to perceive heat, (2) failure to recognize the need to exit the tub, (3) unawareness of impending hazard, (4) fetal damage in pregnant women, (5) physical inability to exit the tub, (6) unconsciousness resulting in the danger of drowning.

WARNING - The use of alcohol, drugs, or medication can greatly increase the risk of fatal hyperthermia.

BATH-SIDE ON/OFF CONTROLS

The On/Off Electronic Button with Timer is the On/Off Button for the HotSoak pump/heater system.

1. Fill tub with water at least 2 inches higher than the highest circulation portal cover.
2. Push the On/Off Button once to turn HotSoak on. Water will circulate through the circulation portals producing a consistent water temperature. The HotSoak system has a built-in timer and will automatically turn off in approximately 20 minutes.
3. To restart HotSoak after it automatically turns off, simply press the On/Off Button again.
4. When HotSoak is running, press the On/Off Button to turn HotSoak off.



OPERATION INSTRUCTIONS

INSTALLATION OF ELECTRONIC ON/OFF TIMER CONTROL

1. Plug the On/Off Timer Control into a dedicated 120-volt, minimum 20-Amp outlet (Speed Timer Box).
2. Wait 10-20 seconds (for self-calibration) before you depress the On/Off Button (Electronic On/Off Button).



1- Speed Timer Box



Electronic On/Off Button

OPERATION INSTRUCTIONS

OPTIONAL CHROMATHERAPY OPERATION

KeyPad Functions	
1: On/Off Pump	
1st Press:	The pump starts
2nd Press:	The pump stops
2: Chromatherapy	
1st Press:	Turn on the light in white
2nd Press:	Rainbow cycle – Low speed
3rd Press:	Rainbow cycle – High speed
4th Press:	Turquoise
5th Press:	Blue
6th Press:	Magenta
7th Press:	Red
8th Press:	Orange
9th Press:	Yellow
10th Press:	Green
11th Press:	Turn off the light <i>(Press and hold 2 seconds at any time to turn off the light.)</i>

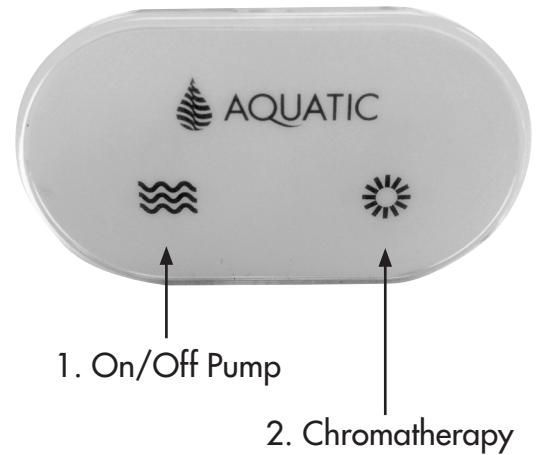

TO REPLACE LED LIGHT

1. Disconnect the power to your bathtub.
2. Drain the bathtub.
3. Open the lens of the fixture using ONLY the proper tool provided for that purpose. Do not attempt to remove the lens without the provided tool.
4. Replace your LED light (replacement LED lights can be obtained from Aquatic).

NOTE: Do not twist LED light into socket. Use gentle pressure and push LED light into place.

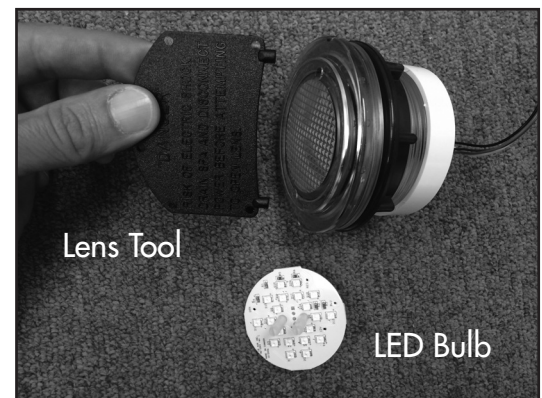

TUB CARE

MAINTENANCE

HotSoak Cleaning

Before tub is used, the HotSoak system should be cleaned and disinfected. Remove all debris and clean tub before putting HotSoak into service. **DO NOT USE ABRASIVE CLEANERS ON THE ACRYLIC FINISH.** Use a non-abrasive detergent and rinse well after cleaning.

- Fill the tub with HOT water to a level 2" above the highest circulation portal cover.
- Add 4 – 6 tablespoons of low-sudsing automatic dishwashing detergent and no more than 24 – 48 ounces of household bleach to the water.
- Operate HotSoak for 10 minutes. Drain.
- Refill with cold water and operate HotSoak for 5 minutes. Drain.

NOTE: DO NOT USE OIL OR OIL BASED BATH ADDITIVES. If you want to use any kind of bath additive, use only a small amount of low-foaming powder or crystal substance; the HotSoak action may intensify the foaming properties of soaps. The use of certain bubble baths and bath additives may increase the level of accumulations of bath residue in the HotSoak system. If excess accumulations persist, you should discontinue use of these products.

If you have followed the monthly purging instructions and still have an excess accumulation of bath residue and desire an alternative cleaning mechanism, we recommend SUPER SYSTEMS CLEAN PLUS (Aquatic part #ST1010) manufactured by Stearns Packaging Corporation to rectify this condition. This may be obtained by calling Aquatic, at (800) 945-2726. It is recommended that you follow the instructions provided by the manufacturer with the product. Repeated use may be necessary. SUPER SYSTEMS CLEAN PLUS does not replace the necessity to purge your HotSoak system at least twice a month with a low foaming detergent and bleach.

Surface Cleaning

Use common household, non-abrasive cleaners for most cleaning jobs. Rinse well and dry with a clean cloth. Never use abrasive cleaners. Do not allow your Lucite® acrylic surface to come into contact with products such as acetone (nail polish remover), nail polish, dry cleaning solution, lacquer thinners, gasoline, pine oil, etc. Remove dust with a soft, dry cloth. Clean grease, oil, paint, and ink stains with isopropyl (rubbing) alcohol.

Surface Scratch Removal

Minor scratches may be removed by polishing your tub with a non-abrasive car polish, followed by buffing. Deeper scratches can be removed by:

- Sanding with wet 400 grit sandpaper.
- Sanding with wet 600 grit sandpaper.
- Sanding with wet micro-grit sandpaper.
- Buffing out using car polish.

REPAIR

The installation and service of your bath should be performed only by a qualified service technician. Remember when contacting your dealer always have your serial number, proof of purchase and model number available. This will ensure a quick response on warranty items. The model and serial numbers are located above the pump on the backside of the tub.

NOTE: ALL WARRANTY REPAIRS MUST BE AUTHORIZED BY AQUATIC BEFORE WORK IS STARTED. FOR SERVICE, ALWAYS CONTACT YOUR DEALER.

CAUTION: Care should be taken to prevent inappropriate chemicals coming in contact with the Lucite® acrylic surface. Please read and observe all instructions and/or warnings on containers containing substances you contemplate applying to your tub. Any failure to comply may void your warranty.

WATER QUALITY

CHEMICAL & WATER QUALITY

Owners of fill and drain bathtubs need to know basic information concerning water quality, how it affects the performance and enjoyment of the operation of their tubs, and steps that can be taken by the owner to correct related problems. Important issues are the microbiological and chemical quality of the water.

1. Microbiological Quality

Microbes are present in water supplied by individual wells or water systems and even in the air around us. These microbes are usually in amounts below what is noticeable. Microbes from the water or air or from a bather's body may settle on wet surfaces such as a bathtub surface or piping system where they can grow in numbers. With regards to air tubs, brown/black fungi/mold or pigmented (colored) bacteria can be noted.

Fungi/Mold - Fungi and mold are always present. Usually the levels are such that we don't notice them. When moisture and temperature are sufficient, the organisms will grow to levels that we may smell and/or see. The best examples of such growth is the very common black growth on the bottom of shower curtains. The best solution to keep these surfaces free from the growth is frequent cleaning.

Pigmented Bacteria - A pinkish substance may appear on bathroom fixtures that is very persistent, appearing in the shower, sink and along the water line of toilet bowls. The residue is less likely a problem associated with water quality than with naturally occurring airborne bacteria. The bacteria may produce a pinkish film, and sometimes a dark gray film, on surfaces that are regularly moist, including toilet bowls, shower heads, sink drains, and tiles. The problem is more common in humid areas of the country. In any particular case, the determination of the exact species of bacteria causing the problem would require lengthy and costly laboratory testing; however, most experts believe the bacteria responsible is *Serratia marcescens*. These bacteria thrive on moisture, dust and phosphates, and are widely distributed in soil, food and also in animals. The best solution to keep these surfaces free from the bacterial film is continual cleaning. A chlorine containing compound is the best cleaner. Avoid abrasives to limit scratching fixtures, which will make them even more susceptible to bacteria.

2. Chemical Quality

The water supplied by individual wells or water systems always contains chemicals, usually in amounts below those which the consumer would notice. Examples of such chemicals, which are of potential concern for the owners of fill and drain bathtubs, are calcium and magnesium salts, copper, iron, manganese and sulfates. When these chemicals are present in sufficient amounts, they may cause problems in bathtubs. You should contact your water supply or treatment company and follow their suggestions for treatment.

Calcium and Magnesium Salts - Collectively, the various compounds of calcium and/or magnesium are referred to as salts. Calcium and magnesium salts are often found in ground water supplies and cause "hardness" in water. Hard and soft water are relative terms. Hard water retards the cleaning action of soaps and detergents, causing expense in the form of extra work and cleaning agents. When hard water is heated, it will deposit a hard scale. With regard to bathtubs, high calcium and/or magnesium levels may result in the formation of white stains and scale formation on the inside of the tubs, especially noticeable with colored tubs. If this occurs, you need to contact the water supplier to determine the calcium and/or magnesium content and/or corrosion potential of the water and follow their suggestions for treatment. If you are on an individual well, you need to contact a water treatment company to test your water and suggest solutions if a problem is present.

Iron - Iron is found in many natural waters especially from wells. Iron in water can also result from the corrosion of piping in the water supply system, such as cast iron mains or galvanized steel service lines, or galvanized piping in the home water system. High iron levels may result in the formation of brown stains in the vicinity of the faucet outlets of various fixtures in the home. With bathtubs, the staining may be particularly pronounced because the aeration

WATER QUALITY

action can oxidize iron to a form that settles out on the inside of the tubs, especially noticeable with white tubs. If high iron in the water is present, you can also notice rust colored deposits inside your toilet tank or dishwasher. If this occurs, you need to contact the water supplier to determine the iron content and/or corrosion potential of the water and follow their suggestions for treatment. If you are on an individual well you need to contact the water treatment company to test your water and suggest solutions if a problem is present.

Manganese - Manganese is found in many natural waters especially from wells. High manganese levels may result in the formation of small black particles that can stain laundry, especially noticeable with whites such as sheets or towels. With bathtubs, the formation of small black particles may be particularly pronounced because the aeration action in the tub can oxidize manganese to an insoluble form that is especially noticeable with white tubs. If high manganese in the water is present, you may also notice black stains on white laundry. If this occurs, you need to contact the water supplier to determine the manganese content of the water and follow their suggestions for treatment. If you are on an individual well, you need to contact a water treatment company to test your water and suggest solutions if a problem is present.

3. Treatment

If you have contacted your water supplier and followed their instructions and you are still having problems, you need to increase the frequency of applications of low-foaming detergent/bleach starting from monthly purging down to using it every other day as required to eliminate your particular problem. The use of certain bath oils, bubble bath soaps and bath additives may increase the level of accumulations of bath residue in the air system. More frequent cleaning may be necessary if these products are used in the air tub. If excess accumulations persist, you should discontinue the use of these products. If you have followed the monthly purging instructions and still have an excess accumulation of bath residue and desire an alternative cleaning mechanism, we recommend **SUPER SYSTEMS CLEAN PLUS** (Aquatic part #ST1010) manufactured by Stearns Packaging Corporation to rectify this condition. This may be obtained by contacting Aquatic at (800) 945-2726. It is recommended that you follow the instructions provided by the manufacturer with the product. Repeated use may be necessary. **SUPER SYSTEMS CLEAN PLUS** does not replace the necessity to purge your air system at least once a month with a low foaming detergent and bleach.

TROUBLESHOOTING GUIDE

WARNING: Always turn off power at the main electrical service panel when servicing your tub.

SYMPTOMS	POSSIBLE PROBLEMS	SUGGESTED SOLUTIONS
Motor does not start	<ol style="list-style-type: none"> 1) GFCI or circuit breaker in OFF position. 2) Fuses blown or thermal overload open. 3) Locked motor shaft. 4) Motor windings burned out. 5) Defective starting switch inside single-phase motor. 6) Disconnected or defective wiring. 7) Low voltage. 	<ol style="list-style-type: none"> 1) Reset GFCI (if optional heater is installed, be sure there are two GFCI circuits.) 2) Contact your electrician. 3) Contact Aquatic. 4) Contact Aquatic. 5) Contact Aquatic. 6) Check and reconnect if needed. 7) Contact your electrician.
Motor does not reach full speed:	<ol style="list-style-type: none"> 1) Low voltage. 2) Inadequate ventilation. 3) Wiring too small. 	<ol style="list-style-type: none"> 1) Contact your electrician. 2) Refer to installer/dealer. 3) Contact your electrician.
Motor overheats (protector trips):	<ol style="list-style-type: none"> 1) Low voltage. 2) Inadequate ventilation. 3) Wiring too small. 	<ol style="list-style-type: none"> 1) Contact your electrician. 2) Refer to installer/dealer. 3) Contact your electrician.
Pump delivers no water	<ol style="list-style-type: none"> 1) Leakage of air into suction system. 2) Impeller clogged. 	<ol style="list-style-type: none"> 1) Check suction screen for clogs. 2) Clean and unplug.
Low pump capacity	<ol style="list-style-type: none"> 1) Suction or discharge line partly plugged. 2) Pump running at reduced speed. 3) Impeller clogged. 	<ol style="list-style-type: none"> 1) Clean and unplug. 2) See "Motor does not reach full speed." 3) Clean and unplug.
Noisy pump and motor	<ol style="list-style-type: none"> 1) Worn motor bearings. 2) Pumps touching a stationary object. 3) Suction line partly plugged. 4) Pump not supported properly. 5) Low voltage. 	<ol style="list-style-type: none"> 1) Contact Aquatic 2) Refer to installer/dealer. 3) Clean and unplug. 4) Contact Aquatic 5) Contact electrician.
Leakage of water at shaft	<ol style="list-style-type: none"> 1) Shaft seal requires replacement. 	<ol style="list-style-type: none"> 1) Contact Aquatic
Leaking unions	<ol style="list-style-type: none"> 1) O-ring missing or damaged. 2) Plumbing in a bind. 3) Loose unions. 	<ol style="list-style-type: none"> 1) Contact Aquatic 2) Contact Aquatic 3) Tighten unions.
Vibration noise	<ol style="list-style-type: none"> 1) Tub or tub plumbing is touching tile/wall. 2) Pump is touching framing. 	<ol style="list-style-type: none"> 1) Refer to installer/dealer. 2) Refer to installer/dealer.

REPLACEMENT PARTS LIST

ILLUSTRATION NO.	PART #	DESCRIPTION
1A.	1126xx	SUCTION COVER
1B.	–	SUCTION WALL FITTING
1C.	–	SUCTION ELBOW
2A.	8171KEYPAD	KEYPAD;TMS; ESTATE+HOTOAK
3A.	8501CONTROL	CONTROL BOX;TMS;W/P ON/OFF
4A. (OPTION)	8500PAD	KEYPAD KIT;TMS TIMER/LIGHT
5A. (OPTION)	8500CONTROL	CONTROL BOX;CHROMATHERAPY 120V
5B. (OPTION)	8020LIGHTS	CHROMATHERAPY;20LEDS BULB;RND CLR
5C. (OPTION)	8LIGHTTOOL	LENS REMOVAL TOOL
5D. (OPTION)	8020LIGHTS	20LEDS CHROMATHERAPY BULB
6A.	8201PUMP	HEATER/MTR.; 120V, 1500W; W/ PUMP

To indicate color, replace XX with "WH" for White, "BI" for Biscuit , "BO" for Bone

REPLACEMENT PARTS MAP

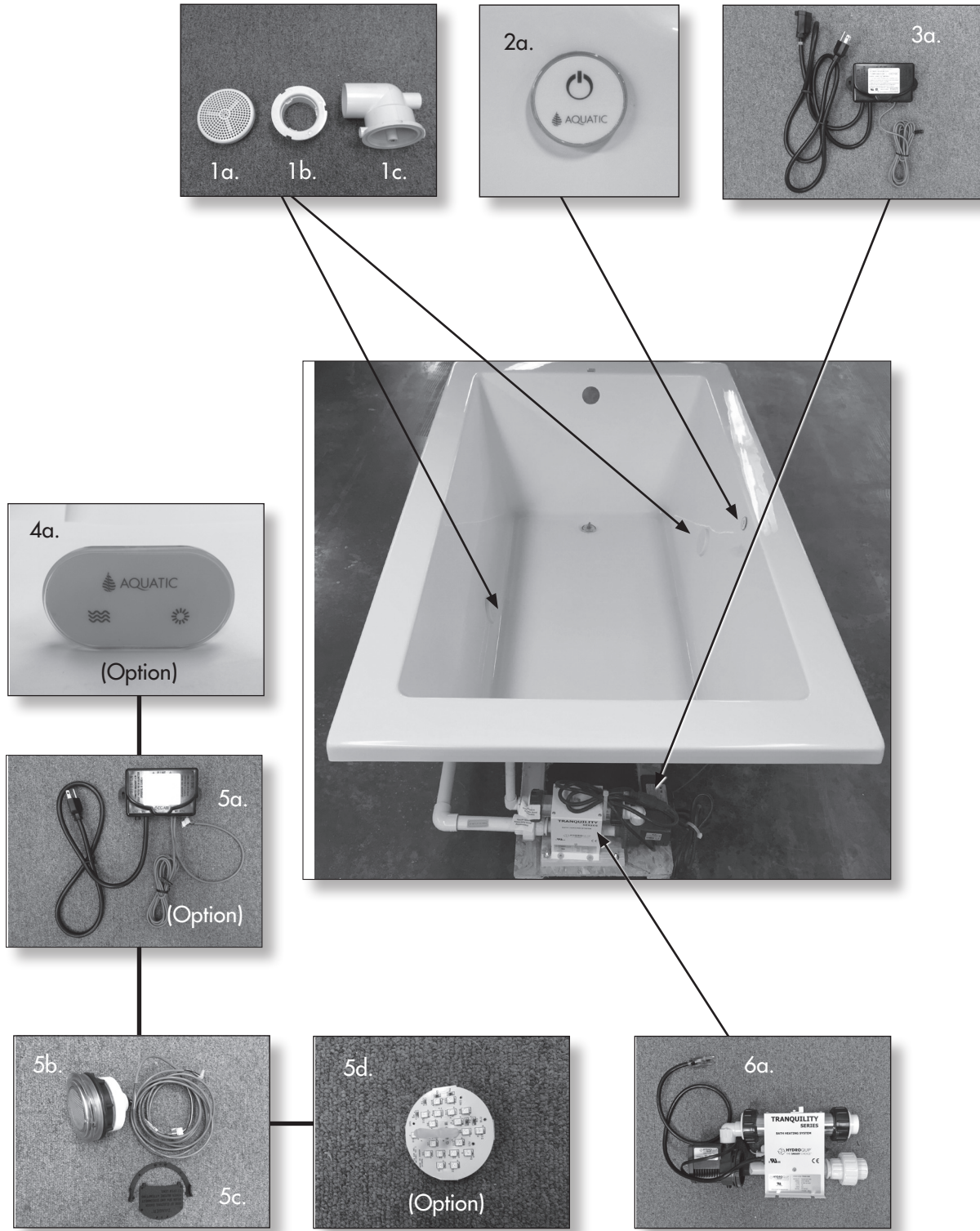



AQUATIC

The bath people

Customer Service: 800.945.2726 • aquaticbath.com