

Ellis 7232 Formerly Serenity 51

72 x 32 x 22 inches



FEATURES ~

- Deep, ergonomic bathing well
- 1" low-profile deck
- Pre-leveled support base
- Slip resistant floor
- Premium cast acrylic surface
- Limited lifetime warranty

AVAILABLE SYSTEMS

AIR BATH

- Perimeter air injectors
- Variable speed heated-air blower
- Automated purge and dry system
- Electronic control with wave and pulse features
- LED Chromatherapy

HOTSOAK

- 2 low-profile circulation portals
- 1.5 kW inline maintenance heater
- Ultra-quiet low flow circulation pump
- Electronic one-touch on/off control
- Heat-bent rigid PVC piping

DRIFTBATH

- Up to 70 water portals
- Quiet, energy-efficient .75 hp pump with integrated heat-transfer
- Electronic control
- 4 high-intensity LED Chromatherapy
- Available in White or Biscuit



Ellis 7232

Formerly Serenity 51

72 x 32 x 22 inches



Note: Drop-in Serenity models feature a pre-leveled support base.

Shown with optional linear overflow trim.

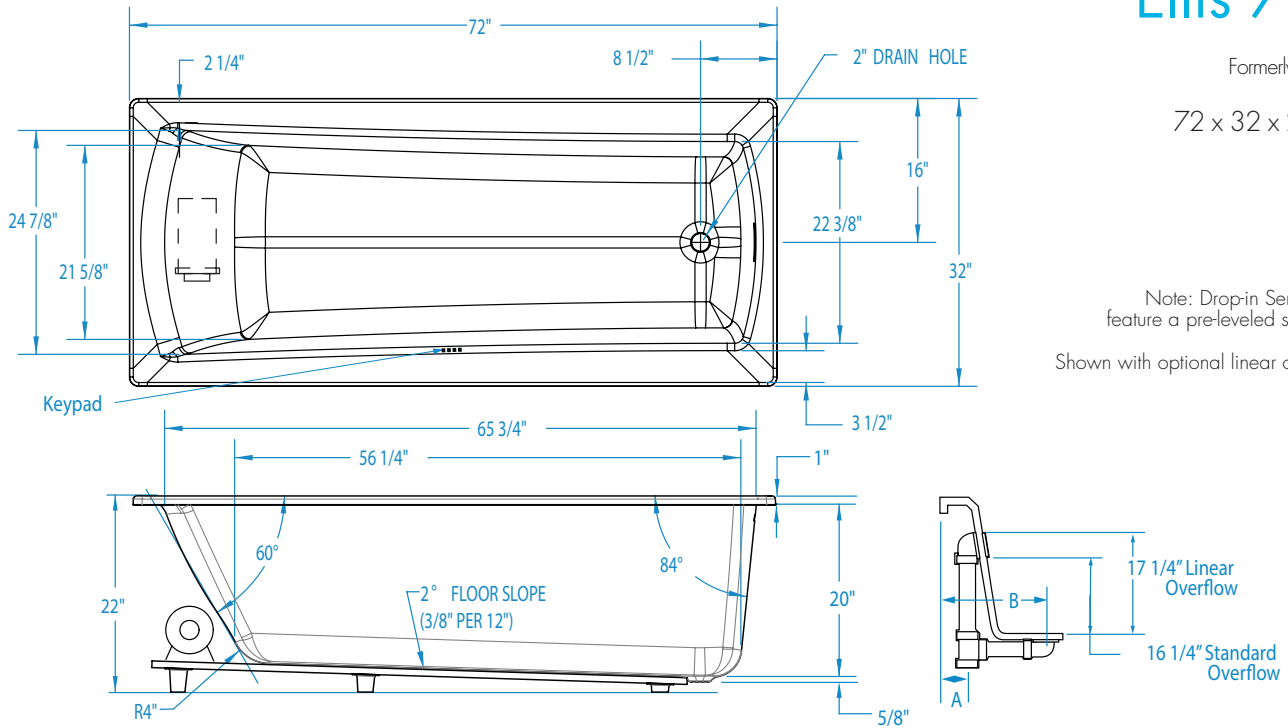

FEATURES

Dimensional Tolerance $\pm 3/8"$. Dimensions needed for site preparation should be measured from the unit. Manufacturer assumes no responsibility for preparatory work.

Type and Model #	Material	System	Powered By	Heater	Controls	Drain	Pkg. Wt. lbs
Soaker #W51AIR7232TO	Cast Acrylic	-	-	-	-	Universal	182
HotSoak #W51AIR7232HS	Cast Acrylic	Water circulation	Pump	1.5 kW Inline maintenance	Electronic	Universal	212
Air Bath #W51AIR7232	Cast Acrylic	Air injection	Variable speed blower	Integrated	Electronic	Universal	212
DriftBath #W51AIR7232DB	Cast Acrylic	Water circulation	Pump	Integrated	Electronic	Universal	223

DIMENSIONS inches

Width Inches	Depth Inches	Height Inches	Skirt Height
72	32	22	-

SUMP DATA inches

Capacity to Overflow gal	Min. Operating Capacity gal	WIDTH @ centerline		DEPTH @ centerline	
		Top	Bottom	Top	Bottom
Standard: 80 Linear: 87	-	65 3/4	56 1/4	24 7/8	21 5/8

PLUMBING DIMENSIONS inches

A	B	Drain Diameter / Clearance
1 3/8	8 1/2	2 / 1 5/8

NOTES:

- 1) Where applicable, utilize cut-out templates packed with unit for deck cutouts.
- 2) 16 x 16 minimum access required at pump/blower location(s).
- 3) If a (3T) tiling flange is selected, then the keypad is located opposite of the flange.

ELECTRICAL DATA

Component	Specification	Requirement
Heated Blower (Air Bath)	10.5 AMP; 120V	15 AMP; 120V, separate circuit; Class A GFCI
Pump/Heater (HotSoak)	1/15 HP; 1.5 kW; 13.5 AMP; 120V	20 AMP; 120V, separate circuit; Class A GFCI
Pump (DriftBath)	3/4 HP; 8.8 AMP; 120V	15 AMP; 120V, separate circuit; Class A GFCI

Each Serenity air bath is equipped with an air heating system to raise the temperature of the air entering the bath. This air temperature will be lower than the bathing temperature of the water, but will help reduce rapid decrease in water temperature. In addition, the air coming from the air jets will feel cool against the skin. This system does not heat the water.